

## Medium Duty Spring Retractable Reels Air/Water - 1/4", 3/8", 1/2" I.D.



- Spool is constructed from a rugged engineered plastic
- Individually powder coated components offer maximum protection from premature corrosion
- The steel guide arm and base are stamped with ribs and gussets to ensure maximum strength and lightest possible weight
- Widened ratchet and latch pawl design greatly reduces wear and increases service life
- The industrial-grade drive spring completely containerized and permanently sealed
- Inlet hose is plumbed into the base to eliminate the risk of undue stress on the swivel
- Guide arm adjusts to seven positions



RT650-OLP



RT605-OLP



RT650-OLP

### New Spool Material and Design!



**Interactive  
Reel Catalog**

Visit [reelcraft.com/catalog](http://reelcraft.com/catalog) for complete product specifications, available parts, and accessories.

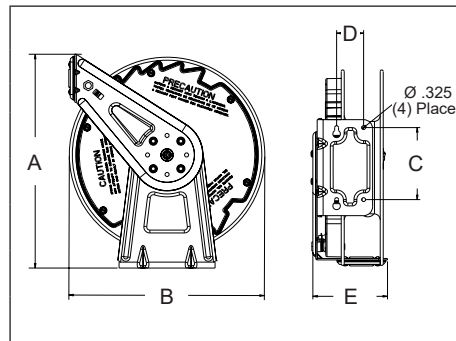

#### Dimensions

	1		2	
	in	mm	in	mm
<b>A</b>	17 <sup>7</sup> / <sub>8</sub>	454	17 <sup>7</sup> / <sub>8</sub>	454
<b>B</b>	16 <sup>1</sup> / <sub>2</sub>	419	16 <sup>1</sup> / <sub>2</sub>	419
<b>C</b>	6	152	6	152
<b>D</b>	2 <sup>1</sup> / <sub>4</sub>	57	2 <sup>1</sup> / <sub>4</sub>	57
<b>E</b>	6 <sup>1</sup> / <sub>4</sub>	159	7 <sup>3</sup> / <sub>4</sub>	197

Model with hose & bumper	Shipping Weight		Hose I.D.		Hose O.D.		Hose Length		*Max Pressure		NPT(M) Hose Outlet	NPT(F) Reel Inlet	NPT(F) Reel Outlet	Size Index #
	lbs	kg	in	mm	in	mm	ft	m	psi	bar	in	in	in	
<b>Low Pressure Air/Water Reels</b> Maximum Temperature 150 °F (65 °C) *Maximum working pressure at 70 °F (20 °C)														
RT425-OLP	19	9	1/4	6	.475	12	25	8	300	21	1/4	3/8	1/4	1
RT435-OLP	21	10	1/4	6	.475	12	35	11	300	21	1/4	3/8	1/4	1
RT450-OLP	24	11	1/4	6	.475	12	50	15	300	21	1/4	3/8	1/4	1
RT625-OLP	20	9	3/8	10	.600	15	25	8	300	21	1/4	3/8	1/4	1
RT635-OLP	21	10	3/8	10	.600	15	35	11	300	21	1/4	1/2	1/4	1
<b>RT650-OLP ★</b>	27	12	3/8	10	.600	15	50	15	300	21	1/4	1/2	1/4	1
RT835-OLP	27	12	1/2	13	.750	19	35	11	300	21	1/2	1/2	1/2	1
RT850-OLP	37	17	1/2	13	.750	19	50	15	300	21	1/2	1/2	1/2	2

Reels supplied with PVC hose.

Model without hose & bumper	Shipping Weight		Hose Capacity				Max Pressure		NPT(F) Reel Inlet	NPT(F) Reel Outlet	Size Index #		
	lbs	kg	I.D.	O.D.	Length		psi	bar	in	in			
<b>Low Pressure Air/Water Reels</b> Maximum Temperature 150 °F (65 °C)													
RT405-OLP	21	10	1/4	6	.475	12	50	15	300	21	3/8	1/4	1
RT605-OLP	22	10	3/8	10	.600	15	50	15	300	21	1/2	1/4	1
RT805-OLP	25	11	1/2	13	.750	19	50	15	300	21	1/2	1/2	2



**Pivot Bases & Swing Brackets**  
See page 39

Models with a ★ icon are our most popular models.